

We support PV systems
Formerly Everest Solar Systems 

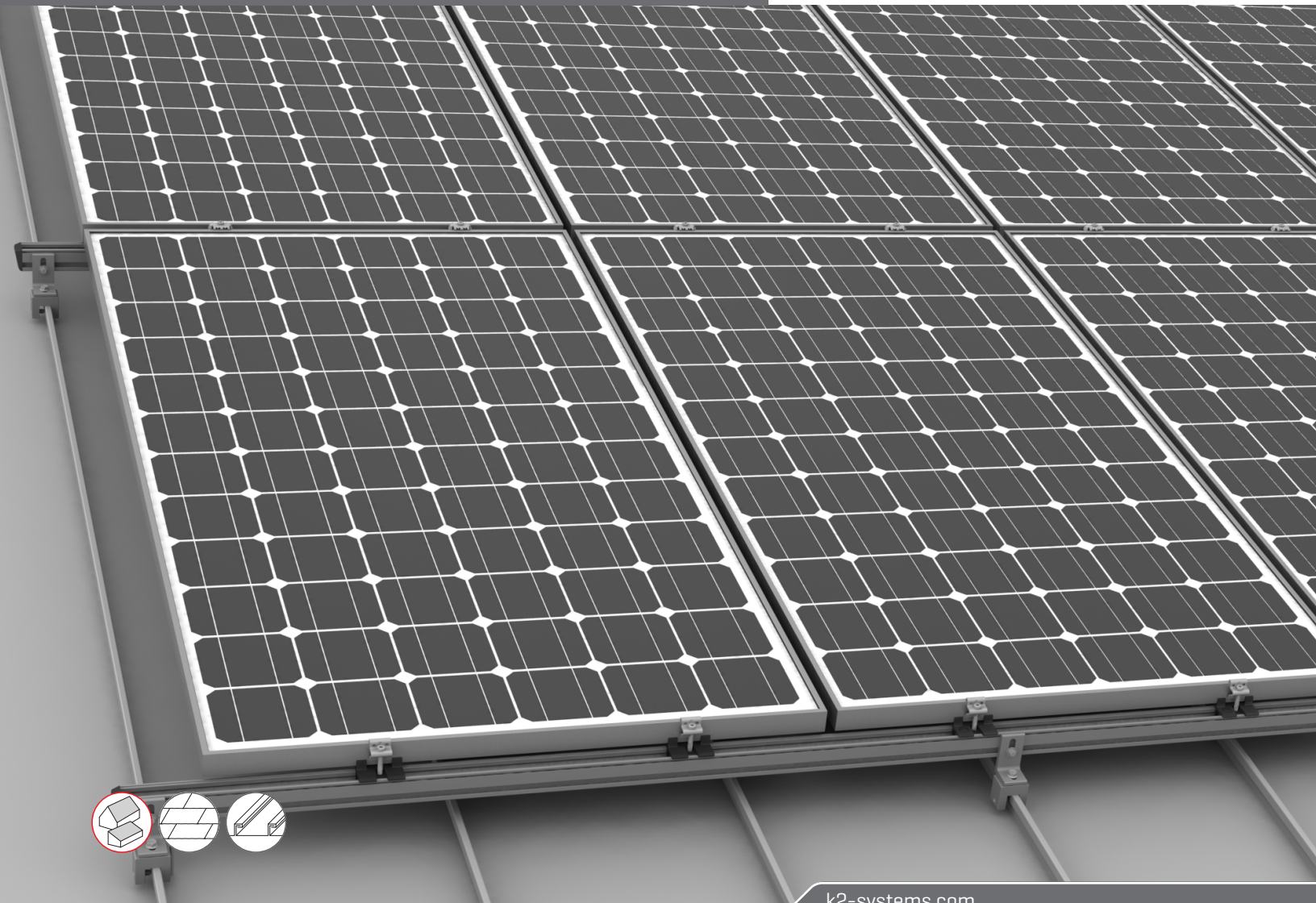

CrossRail Shared Rail System

ASSEMBLY INSTRUCTIONS



Content

▶ About Us	3
▶ General Safety Information	4
· Roof requirements	5
· Structural requirements	5
· Important mounting instructions	5
▶ Bonding and Grounding	6
▶ Fire Rating	7
▶ Compatible Modules	8
▶ Tools Overview	12
▶ Components	13
▶ Assembly	16
▶ Notes	24

Quality tested – several certifications

K2 Systems stands for secure connections, highest quality and precision. Our customers and business partners have known that for a long time. Independent institutes have tested, confirmed and certified our capabilities and components.

Please find our quality and product certificates under:

<https://k2-systems.com/en-US/company/quality-management-and-certificates>

Engineering strength is at our core



With sophisticated product innovations and a deep customer focus, K2 Systems is the engineering leader for all your mounting system needs. We are a market leader with more than 20 GW installed worldwide.

We offer proven product solutions and innovative designs. Wind tunnel testing along with advanced structural and electrical validation to facilitate permitting, design and installation. Our designs result in cost competitive racking systems with dedicated support that will position you to win more projects.

We partner with our customers and suppliers for the long-term. High quality materials and cutting edge designs provide a durable, yet functional system. Our product line is comprised of a few, coordinated components that lower the cost of materials, and simplify installation, saving you time and money. All backed by German engineering, a long track record of quality and a company that is here to stay.

Thank you for choosing K2 Systems for your Solar PV Project.

General Safety Information

Please note that our general mounting instructions must be followed at all times and can be viewed online at <https://k2-systems.com/en-US/downloads/documentation>

- ▶ The equipment may only be installed and operated by qualified and adequately trained installers.
- ▶ Prior to installation, ensure that the product complies with on-site static loading requirements. For roof-mounted systems, the roof load-bearing capacity must always be checked.
- ▶ National and local building regulations and environmental requirements must be adhered to.
- ▶ Compliance with health and safety regulations, accident prevention guidelines and applicable standards are required.
 - Protective equipment such as safety helmet, boots and gloves must be worn.
 - Roofing works must be in accordance with roofing regulations utilizing fall protection safeguards when eaves height exceeds 3 m.
 - At least two people must be present for the duration of the installation work in order to provide rapid assistance in the event of an emergency.
- ▶ K2 mounting systems are continuously developed and improved and the installation process may thereby change at any time. Prior to installation consult our website at: <https://k2-systems.com/en-US/downloads/documentation> for up-to-date instructions. We can send you the latest version on request.
- ▶ The assembly instructions of the module manufacturer must be adhered to.
- ▶ Equipotential bonding/grounding/earthing between individual parts is to be performed according to country specific standards, as well as national laws and regulations.
- ▶ At least one copy of the assembly instructions should be available on site throughout the duration of the installation.
- ▶ Failure to adhere to our general safety and assembly instructions and not using all system components, K2 is not liable for any resulting defects or damages. We do not accept liability for any damage resulting in the use of competitor's parts. Warranty is excluded in such cases.
- ▶ If all safety instructions are adhered to and the system is correctly installed, there is a product warranty entitlement of 25 years! We strongly recommend reviewing our terms of guarantee, which can be viewed at <https://k2-systems.com/en-US/downloads/documentation> We will also send this information on request.
- ▶ Dismantling of the system is performed in reverse order to the assembly.
- ▶ K2 stainless steel components are available in different corrosion resistance classes. Each structure or component must be carefully checked for possible corrosion exposure.

The following guidelines apply



The CrossRail Shared Rail System can be installed as standard under the following conditions. Even if the system is capable of meeting higher demands through the integration of safety standards, please get in touch with your contact at K2 Systems if the specified values are exceeded.



Roof requirements

- ▶ The structural integrity of the roof must be reviewed on site and approved by a licensed structural engineer.
- ▶ Roof mean height: 0-60 ft
- ▶ For allowable roof pitch, refer to the CrossRail engineering letters on our website: <https://k2-systems.com/en-US/downloads/documentation>



Structural requirements

- ▶ Wind speed: 95-200 mph
- ▶ Ground snow load: 0-100 psf
- ▶ Clearance: 2" to 10" clear from the top of the roof to the top of the PV panel
- ▶ Maximum cantilever: $L/3$ where "L" is the span noted in the engineering span tables, provided there is at least 1 module length between maximum cantilevers

Bonding and Grounding

Appropriate means of bonding and grounding are required by regulation. The information provided in this manual shall always be verified with local and national building codes.

Everest Solar Systems has obtained a UL 2703 system listing from Underwriter's Laboratories [UL].

A sample bonding path diagram is shown in Figure 1 below. Your specific installation may vary, based upon site conditions and your AHJ's requirements.

Each electrical connection has been evaluated to a maximum fuse rating of 30A. At least one ground lug per sub array must be used to ground all strings, although additional may be used for redundancy. When installed per these installation instructions, all connections meet the requirements of NEC 690.43.

This racking system may be used to ground and/or mount a PV module complying with UL 1703 only when the specific module has been evaluated for grounding and/or mounting in compliance with the included instructions.

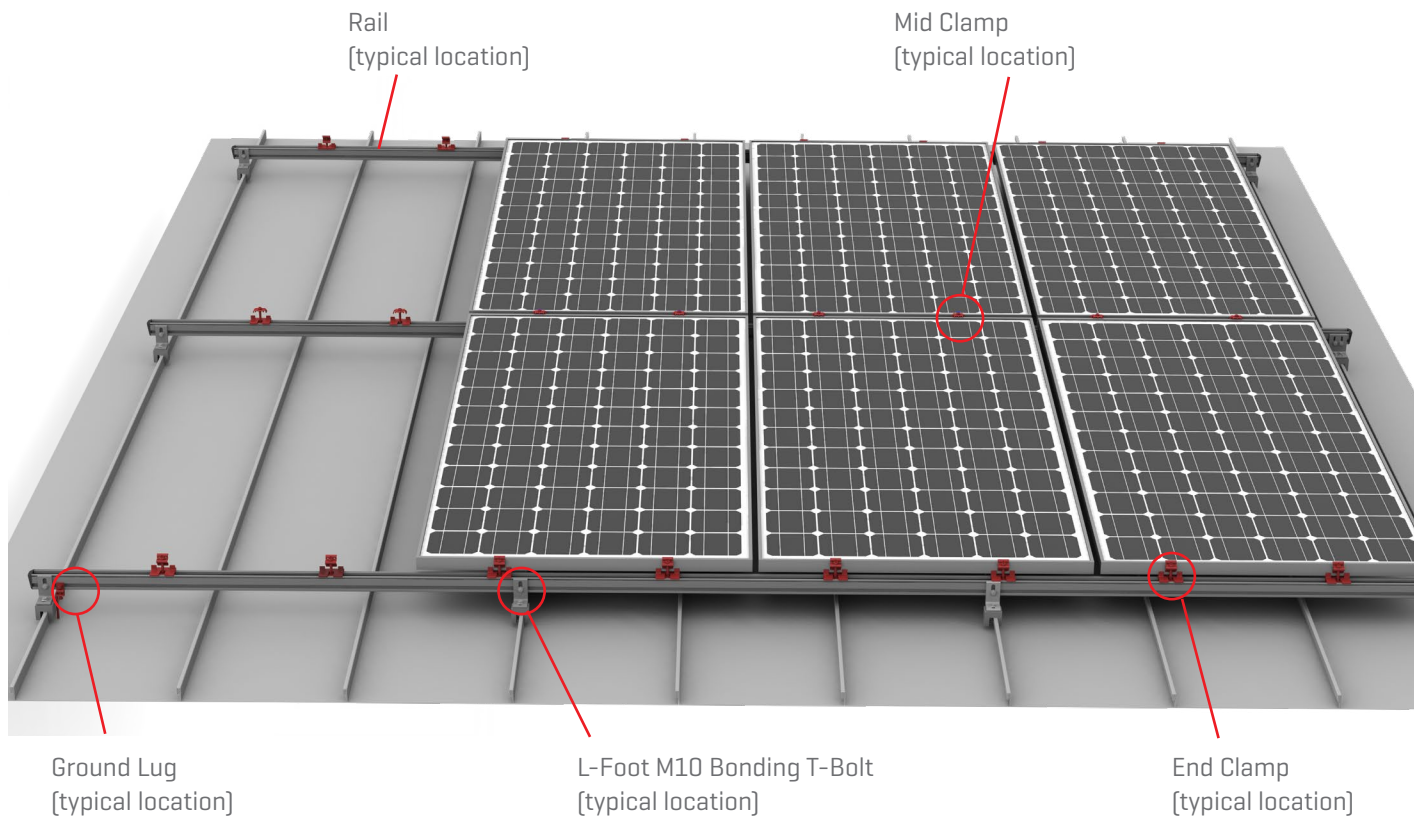

Figure 1: Bonding connections shown in red. For certain jurisdictions, bonding and grounding connections are identified at typical locations.



Fire Rating

The CrossRail Shared Rail System has undergone fire performance testing in accordance with UL 2703, Fire Performance. A System Class A fire rating is achieved when using CrossRail 44-X/48-X/48-XL under the following conditions:

- ▶ Roof slope of 2/12" rise per linear foot or greater
- ▶ Used in combination with a UL 1703 Listed module with a fire performance rating of Type 1, Type 2, or Type 3. Consult the module manufacturer for specific fire performance rating information.
- ▶ CrossRail may be mounted using any stand-off height to maintain the Class A fire rating. Always consult the module manufacturer's installation instructions to ensure your installation is in compliance with their UL 1703 Listing.
- ▶ The results of the racking system do not improve a roof covering Class rating.

All documentation can be found on UL's Online Database as well as K2 Systems' website.

Compatible Modules

K2's CrossRail Shared Rail System was tested with the following:

- ▶ UL/NRTL Listed Aptos Solar Modules:
 - DNA-120-MF26-XXXW
 - DNA-144-MF26-XXXW
 - DNA-120-BF23-XXXW
 - DNA-120-MF23-XXXW
 - DNA-144-BF23-XXXW
 - DNA-144-MF23-XXXW
- ▶ UL/NRTL Listed Axitec Modules:
 - AC-xxP/156-60S
 - AC-xxxM/156-60S
 - AC-xxxP/60V
 - AC-xxxP/60xV
 - AC-xxxP/60S
 - AC-xxxP/60x
 - AC-xxxMH/120S
 - AC-xxxM/60V
 - AC-xxxM/60xV
 - AC-xxxMH/120V
 - AC-xxxM/60S
 - AC-xxxM/60x
 - AC-xxxP/156-72S
 - AC-XXXP/72V
 - AC-XXXP/72XV
 - AC-XXXP/72S
 - AC-XXXP/72X
 - AC-XXXMH/144S
 - AC-XXXM/72V
 - AC-XXXM/72XV
 - AC-XXXMH/144V
 - AC-XXXM/72S
 - AC-XXXM/72X
- ▶ UL/NRTL Listed Boviet Modules:
 - BVM6612M 72-Cell Mono
- ▶ UL/NRTL Listed Canadian Solar Inc. Modules:
 - CS6U-xxx
 - CS6K-xxx
 - CS6X-xxx
 - CS6P-xxx
 - CS3K-xxxP
 - CS3K-xxxMS
 - CS3U-xxxP
 - CS3U-xxxMS
 - CS3W-xxxP
 - CS3U-xxxPB-AG
 - CS3U-xxxMB-AG
 - CS3W-xxxPB-AG
 - CS1H-xxxMS
- ▶ CONTINUED - Canadian Solar Inc Modules:
 - CS6K-xxxM
 - CS6K-P-FG DYMOND
 - CS1Y-xxxMS
 - CS3N-xxxMS
- ▶ UL/NRTL Listed CertainTeed Modules:
 - CTXXXHC11-04
 - CTXXXHC00-04
 - CTxxxHC11-06
- ▶ UL/NRTL Listed ET Solar Modules:
 - ET-M660xxxBB
- ▶ UL/NRTL Listed Hansol Modules:
 - UB-AN1 Black 270-300
 - UBAN1 Silver 270-300
 - UD-AN1 330-360
- ▶ UL/NRTL Listed Hanwha Q Cells Modules:
 - Q.PEAK- G4.1/MAx xxx
 - Q.PEAK BLK G4.1 xxx
 - Q.PRO G4 xxx
 - Q.PLUS G4 xxx
 - Q.PEAK-G4.1/TAA xxx
 - Q.PEAK BLK G4.1/TAA xxx
 - Q.PLUS BFR G4.1/TAA xxx
 - Q.PLUS BFR G4.1/MAx xxx
 - B.LINE PLUS BFR G4.1 xxx
 - B.LINE PRO BFR G4.1 xxx
 - Q.PEAK DUO-G5 xxx
 - Q.PEAK DUO BLK-G5 xxx
 - Q.PEAK DUO-G8 xxx
 - Q.PEAK DUO BLK-G8 xxx
 - Q.PEAK DUO-G7 xxx
 - Q.PEAK DUO BLK-G7 xxx
 - Q.PEAK DUO G7.2 xxx
 - Q.PEAK DUO-G6 xxx
 - Q.PEAK DUO BLK-G6 xxx
 - Q.PEAK DUO BLK-G6+ xxx
 - Q.PEAK DUO-G6+ xxx
 - Q.PEAK DUO-G8+ xxx
 - Q.PEAK DUO BLK-G8+ xxx
 - Q.PEAK DUO L-G8.3 xxx
 - Q.PEAK DUO L-G8.2 xxx
 - Q.PEAK DUO L-G8.1 xxx
 - Q.PEAK DUO L-G8 xxx
 - Q.PEAK DUO L-G7.3 xxx
 - Q.PEAK DUO L-G7.2 xxx
 - Q.PEAK DUO L-G7.1 xxx
 - Q.PEAK DUO L-G7 xxx
- ▶ CONTINUED - Hanwha Q Cells Modules:
 - Q.PEAK DUO L-G6 xxx
 - Q.PEAK DUO L-G6.2 xxx
 - Q.PEAK DUO L-G6.3 xxx
 - Q.PLUS DUO L-G5 xxx
 - Q.PLUS DUO L-G5.1 xxx
 - Q.PLUS DUO L-G5.2 xxx
 - Q.PLUS DUO L-G5.3 xxx
 - Q.PEAK DUO L-G5.2 xxx
 - Q.PEAK DUO L-G5.3 xxx
 - Q.PEAK L-G4.2 xxx
 - Q.PEAK L-G4.1 xxx
 - Q.PLUS L-G4.2 xxx
 - Q.PLUS L-G4.1 xxx
 - Q.PLUS L-G4 xxx
 - Q.PEAK DUO BLK G6+/SC xxx
 - Q.PEAK DUO G5/SC xxx
 - Q.PEAK DUO BLK G5/SC xxx
 - Q.Plus BFR-G4.1xxx
 - Q.Pro BFR-G4.1xxx
 - Q.Pro-G4.1/SCxxx
 - Q.PLUS BFR G4.1 xxx
 - Q.PRO BFR G4 xxx
 - Q.PRO BFR G4.1 xxx
 - Q.PRO BFR G4.3 xxx
 - Q.PEAK-G4.1 xxx
 - Q. PEAK DUO BLK G6+/TS XXX
 - Q.PEAK DUO G5/TS-XXX
 - Q.PEAK DUO BLK G6/TS XXX
 - Q.PEAK DUO G6/TS-XXX
 - Q.PEAK DUO G6+/TS-XXX
 - Q.PEAK DUO ML-G9 XXX
 - Q.PEAK DUO ML-G9.2 XXX
 - Q.PEAK DUO ML BLK-G9 XXX
 - Q.PEAK DUO ML BLK-G9.2 XXX
 - Q.PEAK DUO ML BLK-G9.3 XXX
 - Q.PEAK DUO XL-G9 XXX
 - Q.PEAK DUO XL-G9.2 XXX
 - Q.PEAK DUO XL BLK-G9 XXX
 - Q.PEAK DUO XL BLK-G9.2 XXX
 - Q.PEAK DUO XL BLK-G9.3 XXX
 - Q.PEAK DUO XL -G9.3 XXX
 - Q.PEAK DUO ML -G9.3 XXX
 - Q.PEAK DUO ML BLK -G9.3 XXX
 - Q.PEAK DUO ML -G9 XXX
 - Q.PEAK DUO ML -G9+ XXX
 - Q.PEAK DUO BLK ML -G9+ XXX
 - Q.PEAK DUO BLK ML -G9 XXX
 - Q.PEAK DUO BLK-G10+
 - Q.PEAK DUO BLK ML-G10+
 - Q.PEAK DUO BLK-G10+ / AC
 - Q.PEAK DUO BLK ML-G10.a
 - Q.PEAK DUO XL-G10.d

- ▶ CONTINUED - Hanwha Q Cells Modules:
 - Q.PEAK DUO BLK ML-G10
 - Q.PEAK DUO BLK ML-G10.a+
 - Q.PEAK DUO BLK ML-G10.a+ /TS
 - Q.PEAK DUO XL-G10.2
 - Q.PEAK DUO XL-G10.c
 - Q.PEAK DUO XL-G10.3
 - Q.PEAK DUO ML-G10
 - Q.PEAK DUO ML-G10+
- ▶ UL/NRTL Listed Hyundai Modules:
 - HiS-MxxxMG
 - HiS-MxxxMI
- ▶ CONTINUED - Hyundai Modules:
 - HiS-MxxxTI
 - HiS-MxxxRI
 - HiS-SxxxRI
 - HiS-MxxxRG
- ▶ UL/NRTL Listed Itek Modules
 - IT-xxx-SE
 - Hipro TP672M-xxx
- ▶ UL/NRTL Listed JA Solar Modules:
 - JAP6[DG]
 - JAM6[K]-60-xxx/4BB
- ▶ UL/NRTL Listed Jinko Solar Modules::
 - JKMxxxPP-72-DV
 - JKMxxxPP-60-DV
 - JKMxxxM-60HBL
 - JKMxxxM-72HL-V
 - JKMxxxM-72HL-TV
 - JKMxxx-P-60
 - JKMxxxM-72HL4-TV
 - JKMxxxM-6RL3-B
- ▶ UL/NRTL Listed Kyocera Modules:
 - KUxxxMCA
- ▶ UL/NRTL Listed LG Electronics Inc. Modules:
 - LGxxxS1C-G4
 - LGxxxN1C-G4
 - LGxxxS2W64
 - LGxxxN1K-G4
 - LGxxxN2W-G4
 - LGxxxN1K-A5
 - LGxxxQ1C-V5
 - LGxxxQ1K-V5
 - LGxxxN2W-A5
 - LGxxxS2W-A5
- ▶ CONTINUED - LG Electronics Inc. Modules:
 - LGxxxN2T-A5
 - LGxxxQ1C-A5
 - LGxxxQ1K-A5
 - LGxxxN2W-V5
 - LGxxxN1C-V5
 - LGxxxN1W-V5
 - LGxxxN1K-V5
 - LGXXXN2W-V5
 - LGXXXN1C-V5
 - LGXXXN1W-V5
 - LGXXXN1K-V5
 - LGXXXN2T-V5
 - LGXXXN1C-N5
 - LGXXXQ1C-N5
 - LGXXXQ1K-N5
 - LGXXXN1K-L5
 - LGXXXN2W-L5
 - LGXXXN2T-L5
 - LGXXXN1W-L5
 - LGXXXN1T-L5
 - LGXXXA1C-V5
 - LGXXXA1K-V5
 - LGXXXM1C-N5
 - LGXXXM1K-L5
 - LGXXXQ1C-A6
 - LGXXXQ1K-A6
 - LGXXXQAC-A6
 - LGXXXQAK-A6
 - LGXXXN1C-A6
 - LGXXXN1K-A6
 - LGXXXN2W-E6
 - LGXXXN2W-E6.AW5
 - LGXXXN2T-E6
 - LGXXXN1K-B6
 - LGXXXQ1C-A6
 - LGXXXQ1K-A6
 - LGXXXQAC-A6
 - LGXXXQAK-A6
 - LGXXXN1C-A6
 - LGXXXN1K-A6
 - LGXXXN2W-E6
 - LGXXXN2W-E6.AW5
 - LGXXXN2T-E6
 - LGXXXN1K-B6
 - LGXXXA1C-A6
 - LGXXXM1C-A6
 - LGXXXM1K-A6
 - LGxxxN16-E6
- ▶ UL/NRTL Listed Longi Modules:
 - LR6-72-xxxM [xxx=320-350]
 - LR6-72HV-xxxM [xxx=320-350]
 - LR6-72BK-xxxM [xxx=320-350]
 - LR6-72PE-xxxM [xxx=340-380]
 - LR6-72PH-xxxM [xxx=340-380]
 - LR6-72PB-xxxM [xxx=340-380]
 - LR6-72HPB-xxxM [xxx=360-385]
 - LR6-60-xxxM [xxx=270-300]
 - LR6-60HV-xxxM [xxx=270-300]
 - LR6-60BK-xxxM [xxx=270-300]
 - LR6-60PE-xxxM [xxx=280-320]
 - LR6-60PH-xxxM [xxx=280-320]
 - LR6-60PB-xxxM [xxx=280-320]
 - LR6-72BP-xxxM
 - LR6-60BP-xxxM
 - LR6-72HBD-xxxM
 - LR6-60-xxxM
 - LR6-60BK-xxxM
 - LR6-60PE-xxxM
 - LR6-60PB-xxxM
 - LR6-60PH-xxxM
 - LR6-60HPB/HIB-xxxM
 - LR6-60HPH/HIH-xxxM
 - LR6-72-xxxM
 - LR6-72BK-xxxM
 - LR6-72HV-xxxM
 - LR6-72PE-xxxM
 - LR6-72PB-xxxM
 - LR6-72PH-xxxM
 - LR6-72HPH/HIH-xxxM
 - LR6-72BP-xxxM
 - LR6-72HBD/HIBD-xxxM
 - LR6-60BP-xxxM
 - LR6-60HBD/HIBD-xxxM
 - LR4-60HPH/HIH-xxxM
 - LR4-60HPB/HIB-xxxM
 - LR4-72HPH/HIH-xxxM
 - LR4-72HBD/HIBD-xxxM
 - LR4-72HBD/HIBD-xxxM
- ▶ UL/NRTL Listed Lumos Modules:
 - LSxxxx-60M-B/C
- ▶ UL/NRTL Listed Luxor Solar Modules:
 - Lx-xxxP
 - Lx-xxxM

Compatible Modules continued

K2's CrossRail Shared Rail System was tested with the following:

▶ UL/NRTL Listed Mission Solar Modules:

- MSExxxSB1J
- MSExxxS05T
- MSExxxS04J
- MSExxxSQ6S
- MSExxxS06J
- MSExxxSQ4S
- MSExxxSQ5T
- MSExxxSQ5K
- MSExxxSQ8T
- MSExxxSQ8K
- MSExxxSQ9J
- MSExxxSQ9S
- MSExxxSR8T
- MSExxxSR8K
- MSExxxSR9S
- MSExxxSB1J
- MSExxxSX5T
- MSExxxSX5K
- MSExxxSX6S
- MSExxxSX6W
- MSExxxSX6Z
- MSExxxSX5R

▶ UL/NRTL Listed Panasonic Modules:

- VBHNxxxSA16
- VBHNxxxKA01
- VBHNxxxKA03
- VBHNxxxKA04
- VBHNxxxSA17
- VBHNxxxSA18
- VBHNxxxSA17E
- EVPVxxx
- EVPVxxxK

▶ UL/NRTL Listed Peimar Modules:

- SGxxxP-[BF]
- SGxxxP
- SGxxxM-[BF]
- SGxxxM

▶ UL/NRTL Listed Phono Solar Modules:

- PSxxxMG-20/U
- PSxxxPG-20/U
- PSxxxM-20/U
- PSxxxMH-20/U

▶ UL/NRTL Listed Prism Solar Modules:

- Bi48 xxx Bifacial
- Bi60 xxx Bifacial

▶ UL/NRTL Listed REC Modules:

- RECxxxTP2 BLK2
- RECxxxTPS 72
- RECxxxTP2S 72 XV
- RECxxxTP2SM 72 XV
- RECxxxTP2SM 72
- RECxxx NP
- RECxxx NP Black
- RECxxxAA
- RECxxxAA Black
- RECxxxTP4
- RECxxxAAPure
- RECxxxTP4Black

▶ UL/NRTL Listed Sanyo Electric Co Ltd of Panasonic Group Modules:

- VBHNxxxSA16
- VBHNxxxSA17
- VBHNxxxSA18
- VBHNxxxSA16
- VBHNxxxSA17
- VBHNxxxSA18
- VBHNxxxKA01
- VBHNxxxKA03
- VBHNxxxKA04

▶ UL/NRTL Listed Seraphim Modules:

- SEG-XXX-6MA-HV
- SEG-XXX-BMA-HV

▶ UL/NRTL Listed Silfab Modules:

- SLAxxxM
- SLG-M-xxx
- SLA-x-xxx
- SLG-x-xxx
- SIL-xxx BL
- SIL-xxx HL
- SIL-xxx NL
- SIL-xxx ML
- SIL-xxx NT
- SIL-xxx BK
- SIL-xxx NU
- SIL-xxx NX
- SIL-xxx HC

▶ UL/NRTL Listed Sharp Modules:

- NU-SCxxx
- NU-SAxxx

▶ UL/NRTL Listed Solaria Modules:

- PowerxT® -xxxR-PD
- PowerxT® -xxxR-BD

▶ UL/NRTL Listed Solarworld Modules

"Sunmodule":

- Plus SW XXX Mono
- Plus SW XXX Poly

▶ UL/NRTL Listed Soluxtec Modules:

- FR xxx Wp
- Power Slate 54 Mono Dark Series
- Power Slate 54 Mono Series

▶ UL/NRTL Listed SunPower Modules:

- SPR-E19-xxx
- SPR-E20-xxx

▶ UL/NRTL Listed Sunpreme Modules:

- GxB-xxx
- GxB-xxxSM
- GxB-xxxSL

▶ UL/NRTL Listed Sunspark Modules:

- SST-275-300M
- SMX-250-265P
- SST-xxxM 60 cell
- SST-xxxM 72 cell
- SST-xxxMB 60 cell
- SST-XXXM3B-60/72
- SST-XXXM3-60/72
- SST-XXXM3B-60/72

▶ UL/NRTL Listed S-Energy Modules:

- SN15-60PAE/PCE-xxxV
- SN10-60PAE/PBE/PCE-xxxV
- SN15-60MAE/MCE-xxxV
- SN10-60MAE/MCE-xxxV
- SNxxxM-10T(SN60)
- SN15-72PAE/PCE-xxxV
- SN10-72PAE/PBE/PCE-xxxV
- SN15-72MAE/MCE-xxxV
- SN10-72MAE/MBE/MCE-xxxV
- SN20-60MAE/MBE/MCE-xxxV
- SN25-60MAE/MCE-xxxV
- SC20-60MAE/MBE/MCE-xxxV
- SC25-60MAE/MCE-xxxV
- SN20-72MAE/MBE/MCE-xxxV
- SN25-72MAE/MCE-xxxV
- SC20-72MAE/MBE/MCE-xxxV
- SC25-72MAE/MCE-xxxV
- SD25-60BDE-xxxV

Compatible Modules continued



K2's CrossRail Shared Rail System was tested with the following:

- ▶ UL/NRTL Listed Talesun Modules
 - Hipro TP660M-xxx
 - Hipro TP672M-xxx

- ▶ UL/NRTL Listed Trina Solar Modules:
 - TSM-xxxDE14A
 - TSM-xxxDD05A.08
 - DUOMAX SPECS 1. PEG14
 - DUOMAX SPECS 2. PEG5
 - DUOMAX SPECS 3. PEG5.07
 - DUOMAX SPECS 4. PDG5
 - TSM-DE15H[II]
 - TSM-DE15M[II]
 - TSM-DD06M.05[II]
 - TSM-DD06H.05[II]
 - TSM-DD06M.t5[II]
 - TSM-DD06H.T5[II]
 - TSM-PE15H
 - TSM-DEG15HC.20[II]
 - TSM-DEG15MC.20[II]
 - TSM-DEG6HC.20[II]
 - TSM-DEG6MC.20[II]
 - TSM-xxxDE15V[II]
 - TSM-xxxDE19
 - TSM-xxxDEG15VC.20[II]
 - TSM-xxxDEG19C.20

- ▶ UL/NRTL Listed V Energy Modules:
 - Series 200 PV

- ▶ UL/NRTL Listed Yingli Solar Modules:
 - YL-xxxP-29b
 - YL-xxx-35b

Tools Overview

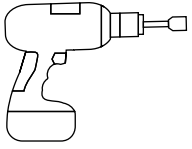

13mm



6 - 35 Nm
(4.5 - 22.2 lb-ft)



6mm



≥ 3.0 m

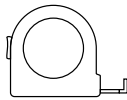

≥ 6.0 m

Optional

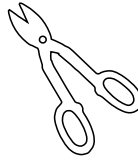

Torque Overview

- ▶ M10 T-Bolts: 25.8 ft-lb [35 Nm]
- ▶ WEEB Lug 10.3: 15 ft-lb [20.3 Nm]
- ▶ End Clamp UL2703+: M8 Allen Bolts 10.3 ft-lb [14 Nm]
- ▶ All other components: M8 Hex Bolts: 10.3 ft-lb [14 Nm]

Tools and materials for the installation of third party items such as roof attachment products, roof covering and sealing products or items used for bonding and grounding are not listed here. Please refer to the instructions of those third party products.

Components

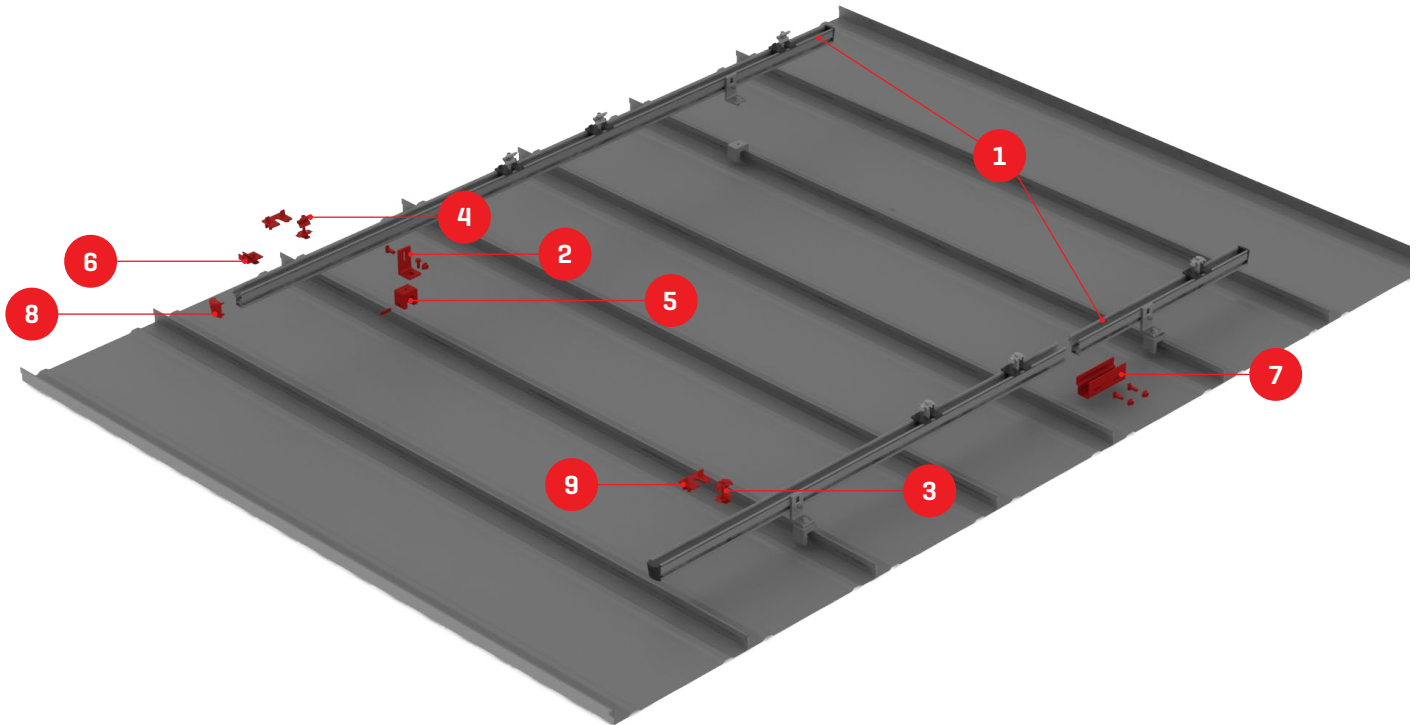

- 1** 4000019/4000020/4000021/4000022
4000662/4000675
4000695/4000705

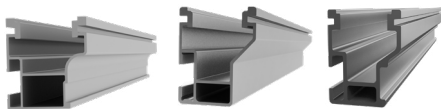

CrossRail 44-X, 48-X or 48-XL

- 2** 4000630/4000631



L-Foot Slotted Set

- 3** 4000601-H/4000602-H
4000688-H/4000689-H

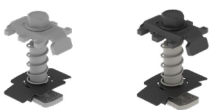

Mid Clamp, 13mm Hex
30 - 50 mm module frame height

- 4** 4000429/4000430
4000050-H



End Clamp or Yeti Clamp
30 - 50 mm module frame height

5 4000016/4000017



Standing Seam PowerClamp
Available in Mini and Standard sizes

6 4000006-H



Everest Ground Lug, 13mm Hex

7 4000051/4000052
4000385/4000386

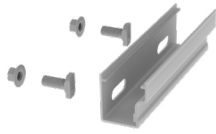

Structural Rail Connector
CR 44-X or 48-X/48-XL

8 4000067
4000431/4000433



End Cap
CR 44-X or 48-X/48-XL

9 4000609/4000632

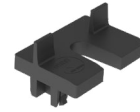

Add-On
Available in 5mm or 10mm

Other Roof Attachments & Accessories

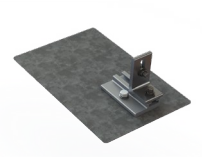

EverFlash eComp + SR Kit
Available in Mill or Dark
4000015/4000027/4000029



**CR Microinverter & Optimizer
Mounting Kit, 13mm Hex**
4000629-H



CrossRail 3" Black Sleeve
Compatible with CR 48-X/48-XL
4000583



TC Wire Management Clip
4000069



Omega Cable Clip
4005394



HEYCO Sunrunner Cable Clip
4000382

Important note for Yeti Clamp installs



The Yeti Clamp must be installed in an array. It cannot be installed on a single module that is not connected to the array by a mid clamp.

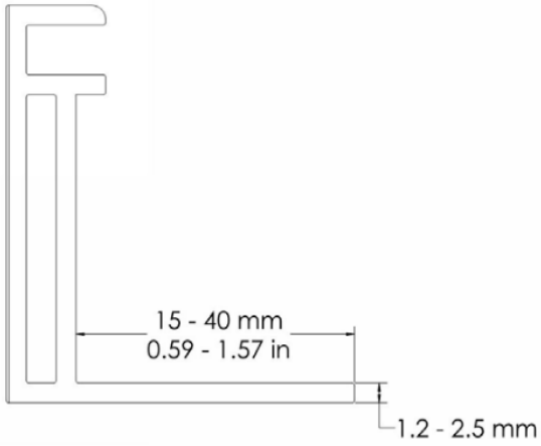

Frame Compatibility:
Flange Thickness = 1.2 - 2.5 mm
Flange Width = 15 - 40 mm

Assembly

Standing seam

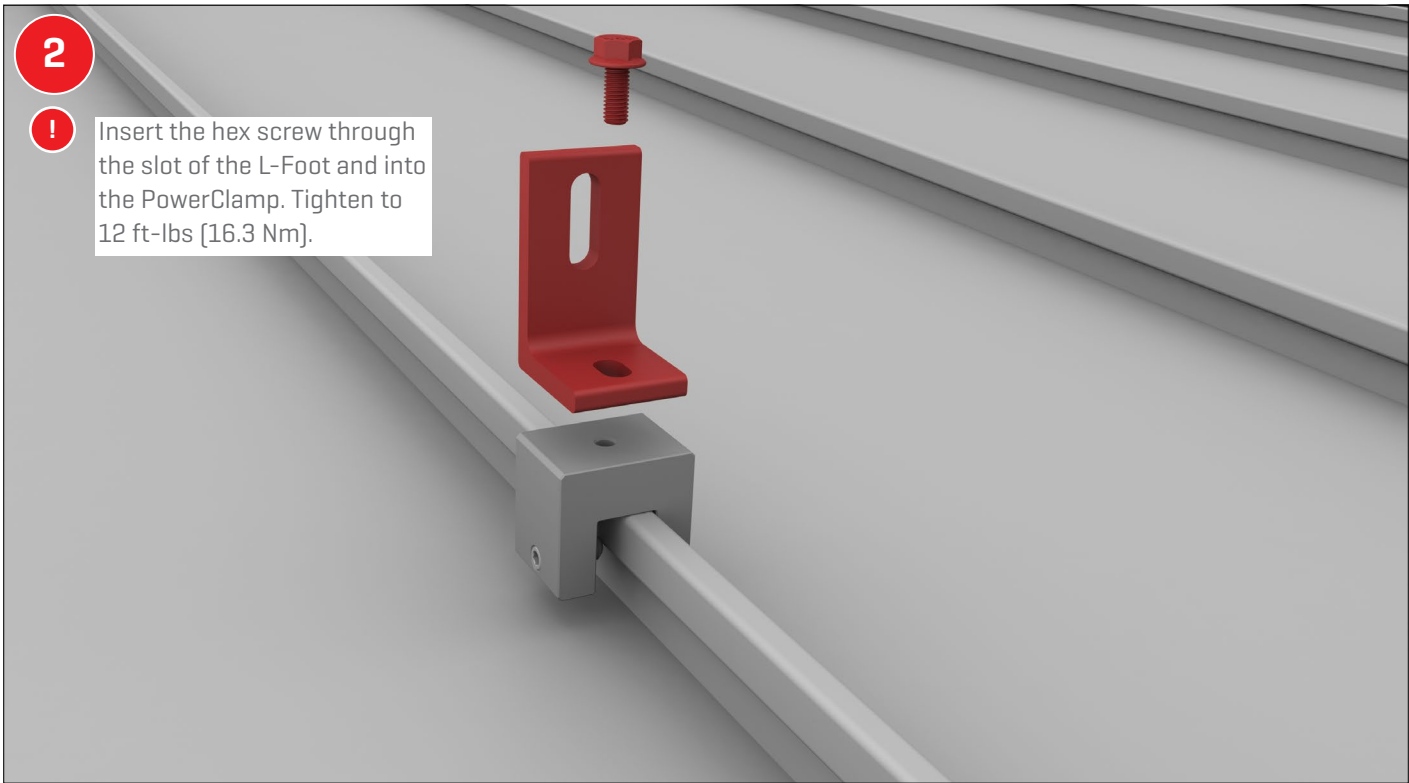
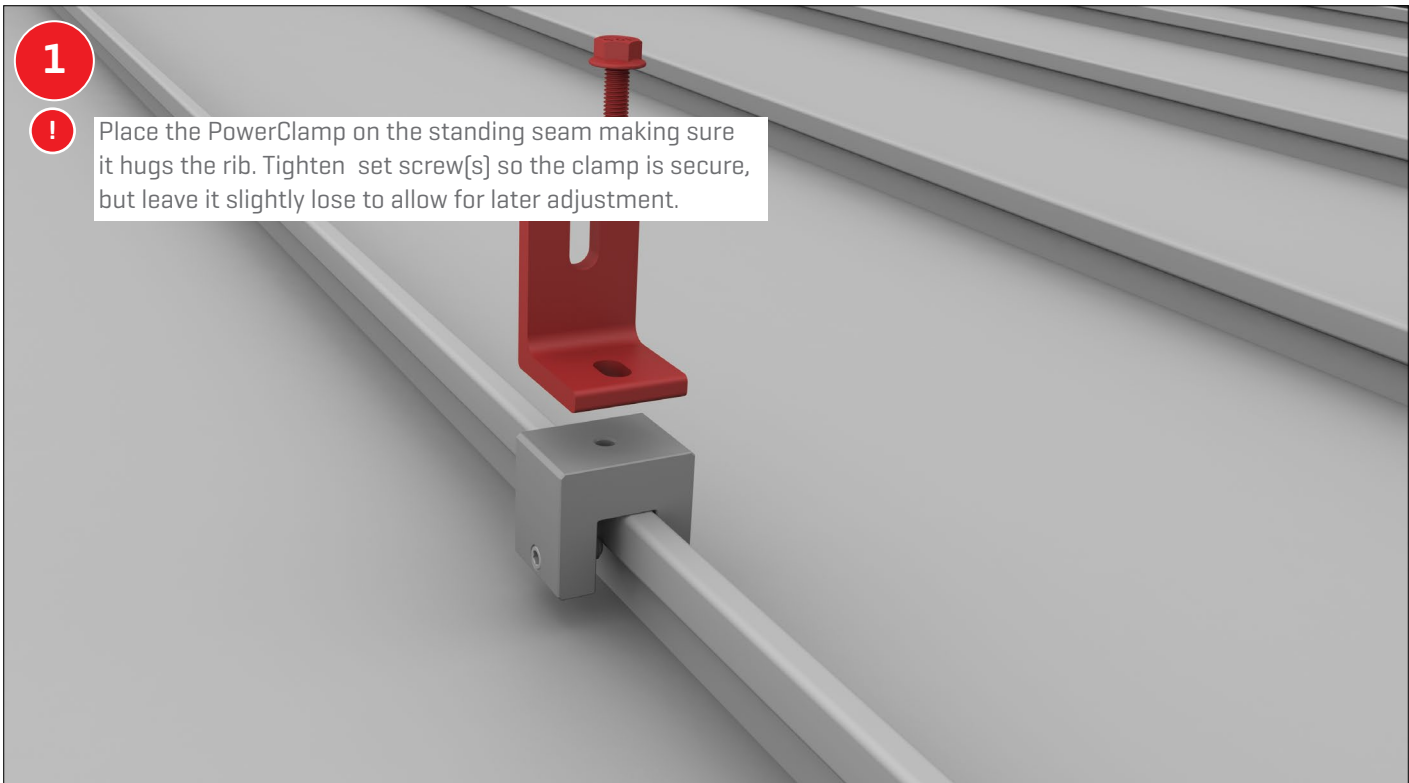

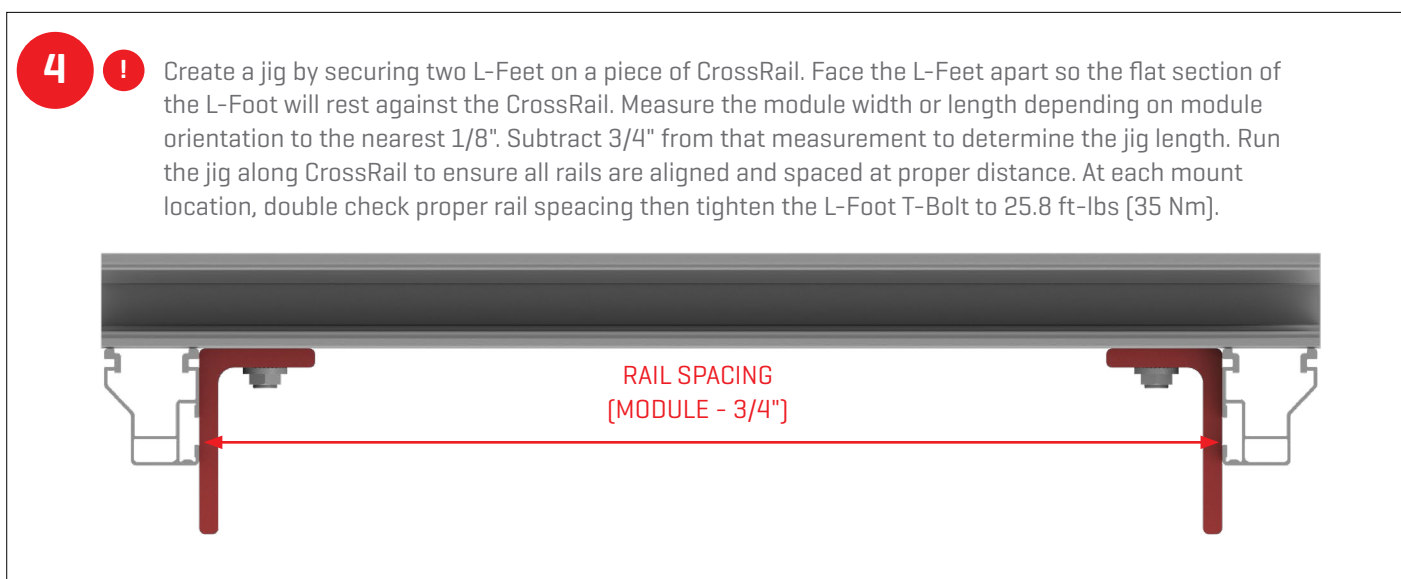
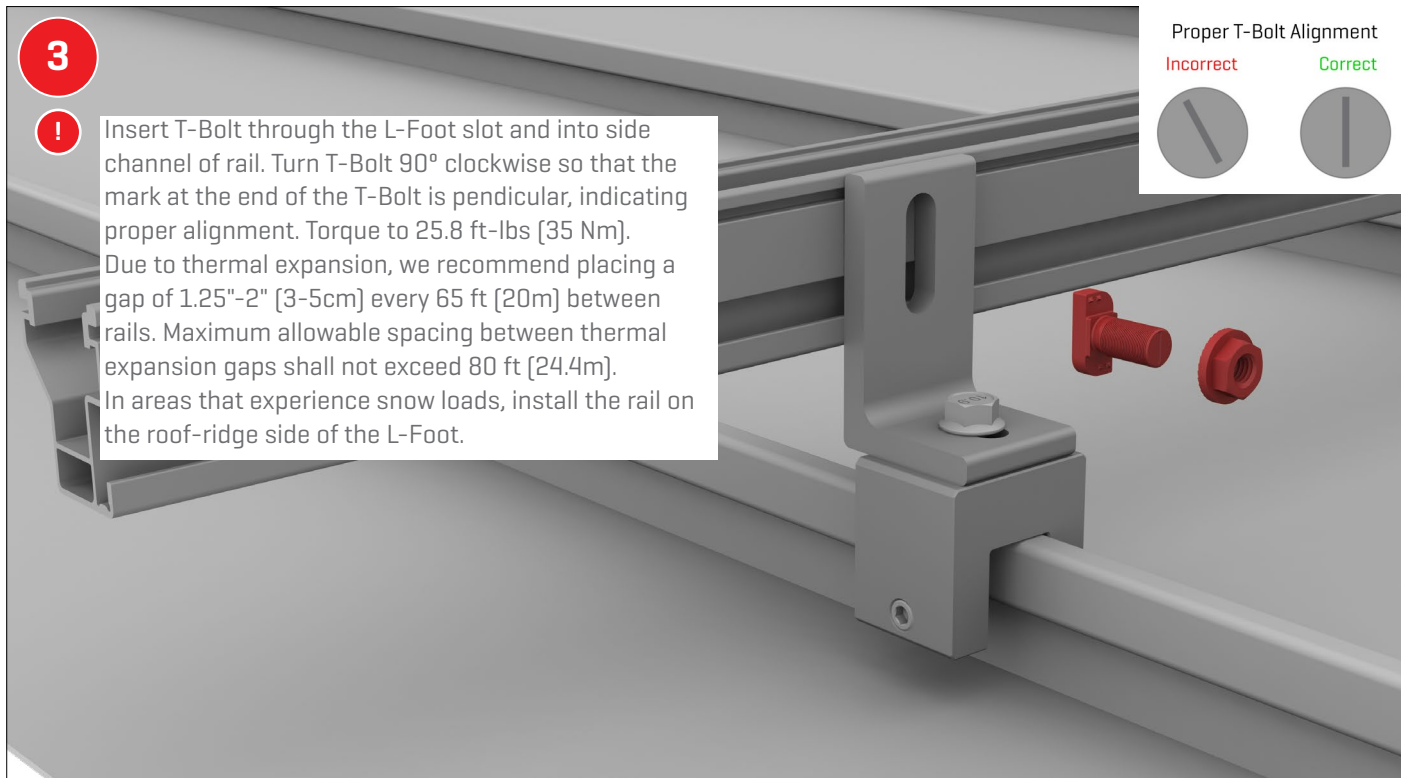

Example	Measured Module Length [used for portrait installation]	Jig Dimensions for Portrait Insallation	Measured Module Width [used for landscape installation]	Jig Dimension for Landscape Installation [rail spacing]
English Units	64 1/2"	$64 \frac{1}{2} - \frac{3}{4} = 63 \frac{3}{4}"$	39 3/8"	$39 \frac{3}{8} - \frac{3}{4} = 38 \frac{5}{8}"$
Metric Units	1639mm	$1639 - 19 = 1620\text{mm}$	1000mm	$1000 - 19 = 981\text{mm}$

5



Align the two rail ends next to each other. Slide rail connector from below rails, centering the connector between the two rail ends. Ensure rail connector does not interfere with an L-Foot or roof attachment. Attach rail connector using two T-Bolts and serrated hex nuts per side (4 total). Ensure that the slot on the bottom of the T-Bolt is perpendicular to the rail, indicating proper alignment. Torque to 25.8 Ft-Inbs [35 Nm].

Proper T-Bolt Alignment

Incorrect

Correct

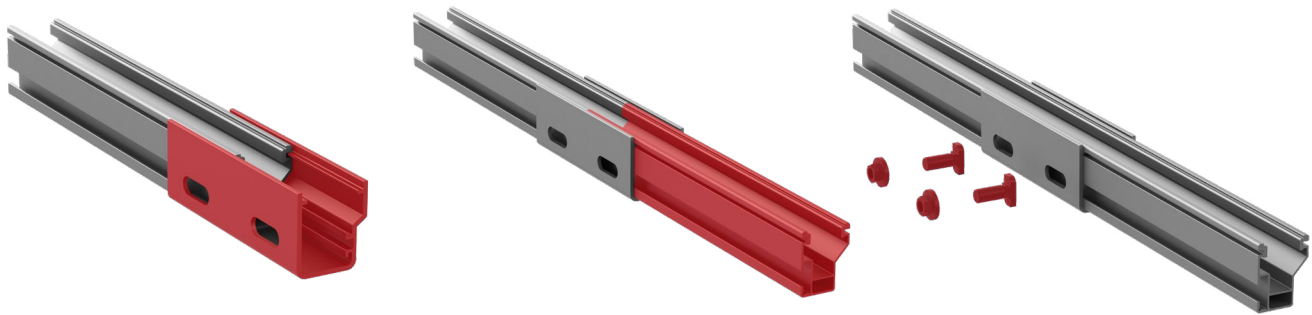

6



Using the CrossRail Microinverter and Optimizer Mounting Kit hardware from K2 Systems, attach your chosen device to the top channel of Cross-Rail. Torque to 10.3 ft0lbs [14 Nm].



7 Optional

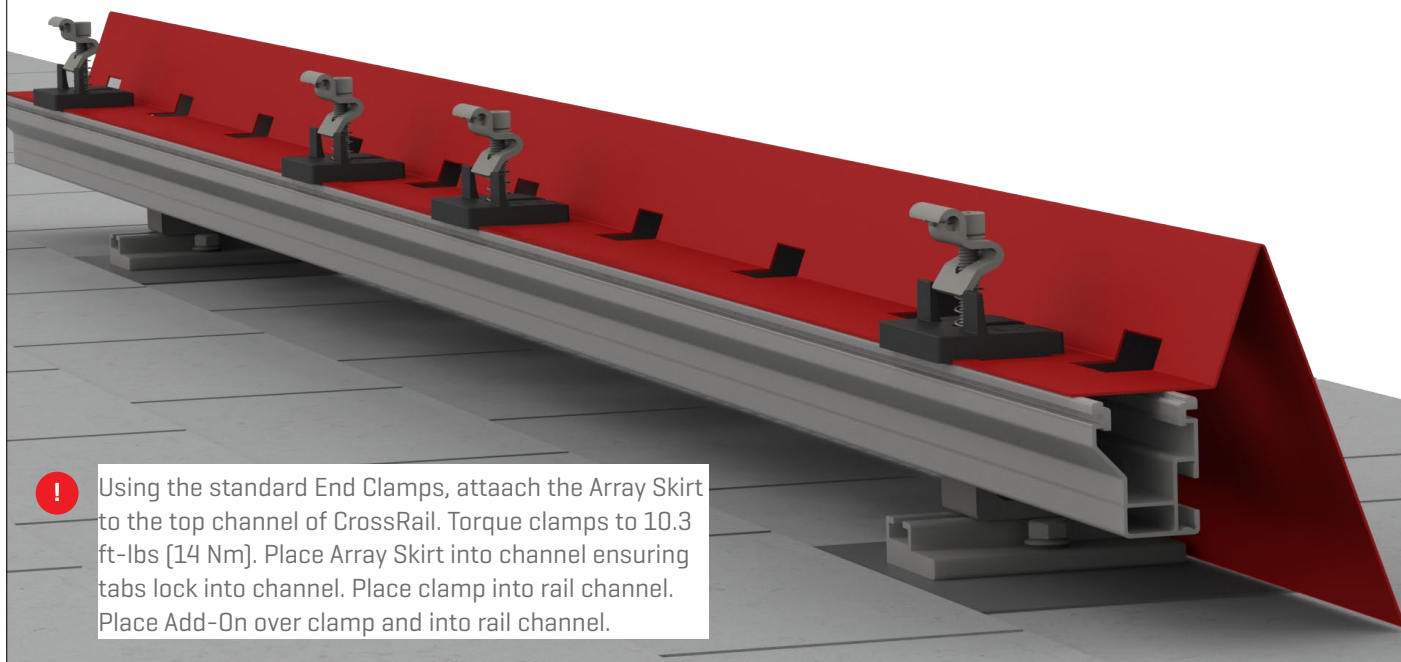

8a

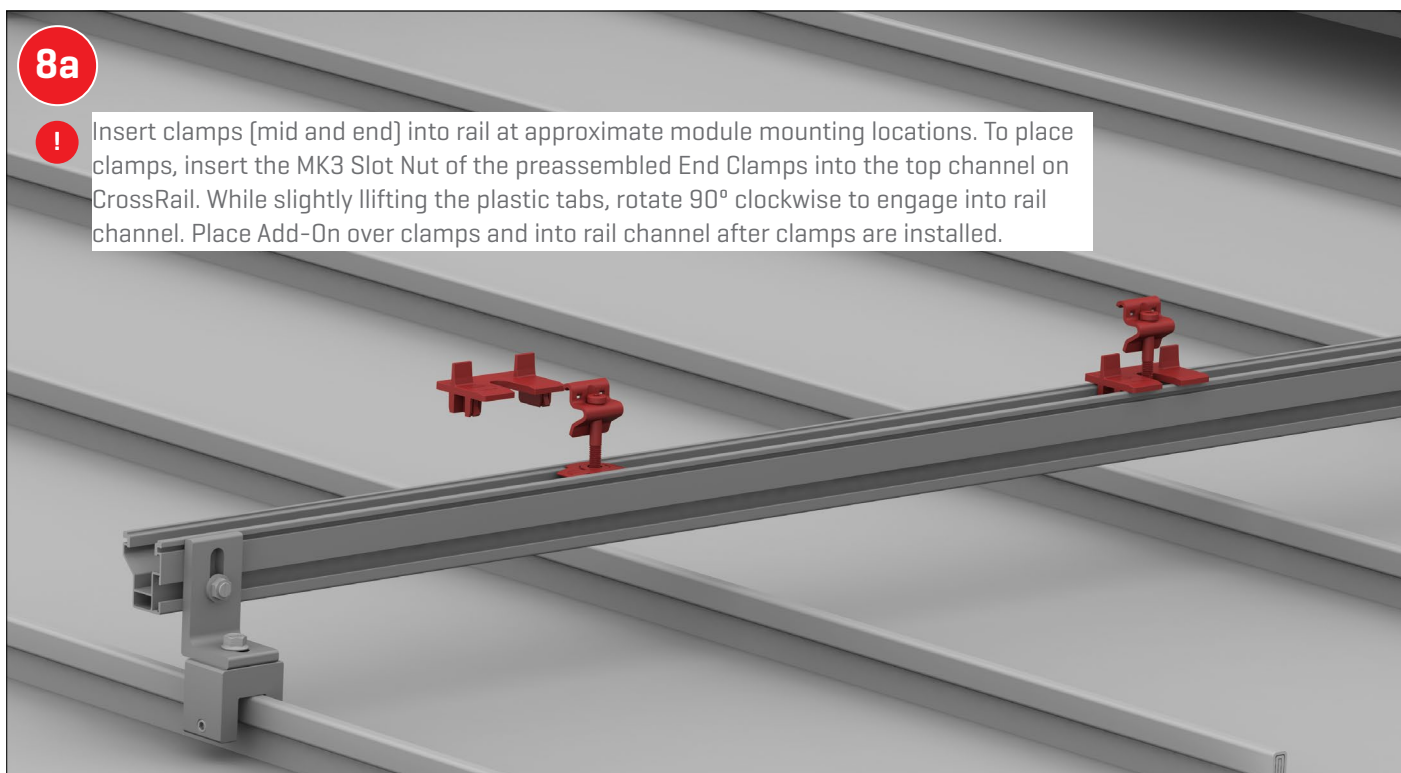

8b

- ! Push zip tie up into leash channel located on bottom of Yeti Clamp. Slide clamp into rail channel with bolt facing outward. Leave enough room for the module to be placed. Place the module flush to end of rail. Pull leash toward you so the clamp slides over module frame. Torque to 12 ft-lbs. Use your hand to ensure the Yeti Clamp is fully engaged with the frame of the module as shown in the image. Note: The Yeti Clamp must be installed in an array. It can-not be installed on a single module that is not connected to the array by a mid clamp.

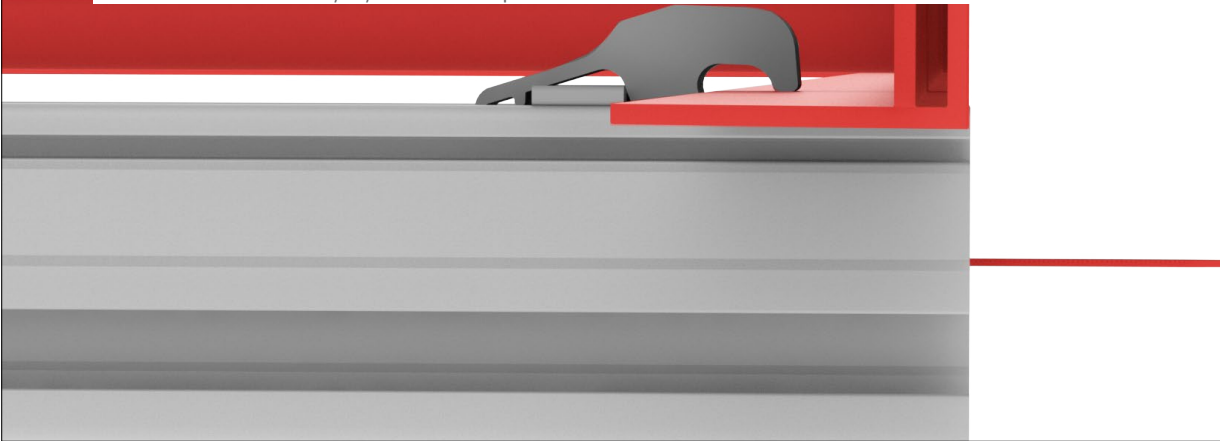

9

- ! Lay modules down in a row one at a time. Safely connect and properly manage wires before module installation. We recommend starting at the bottom module row and working up.

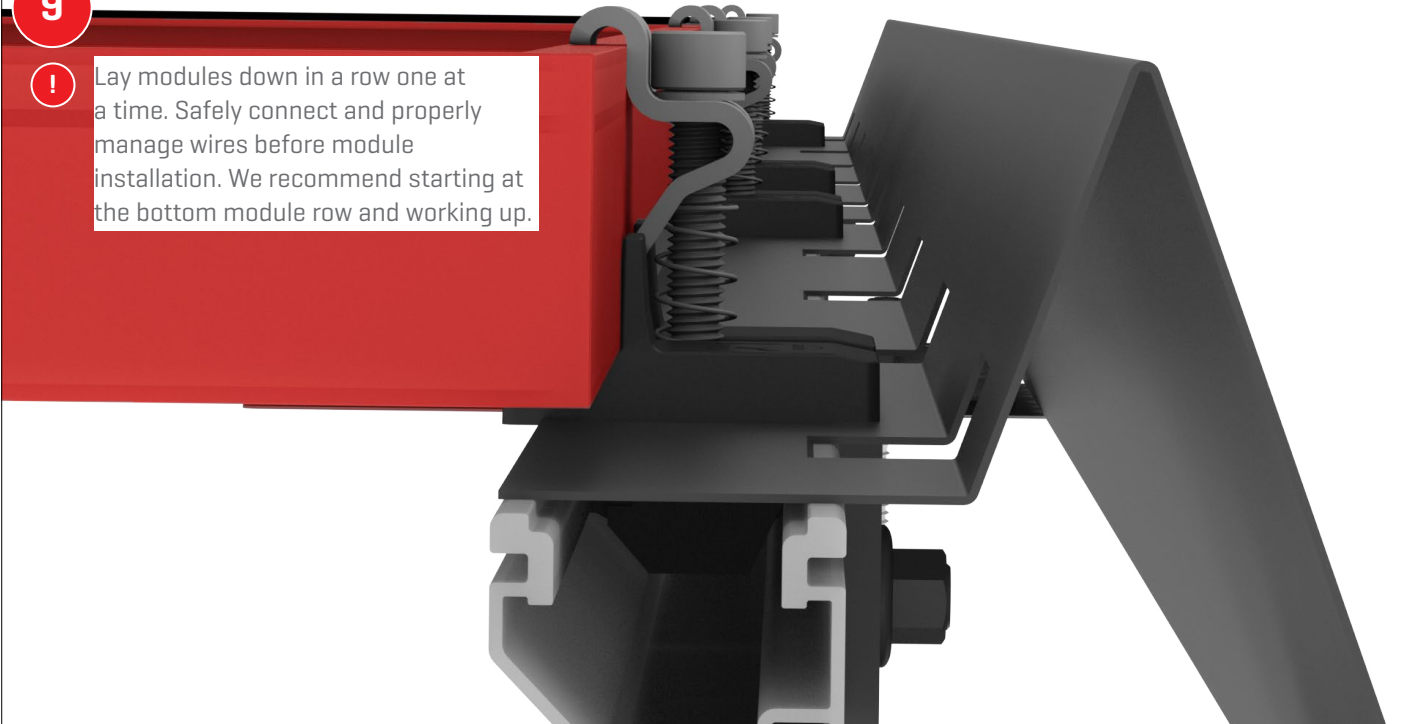

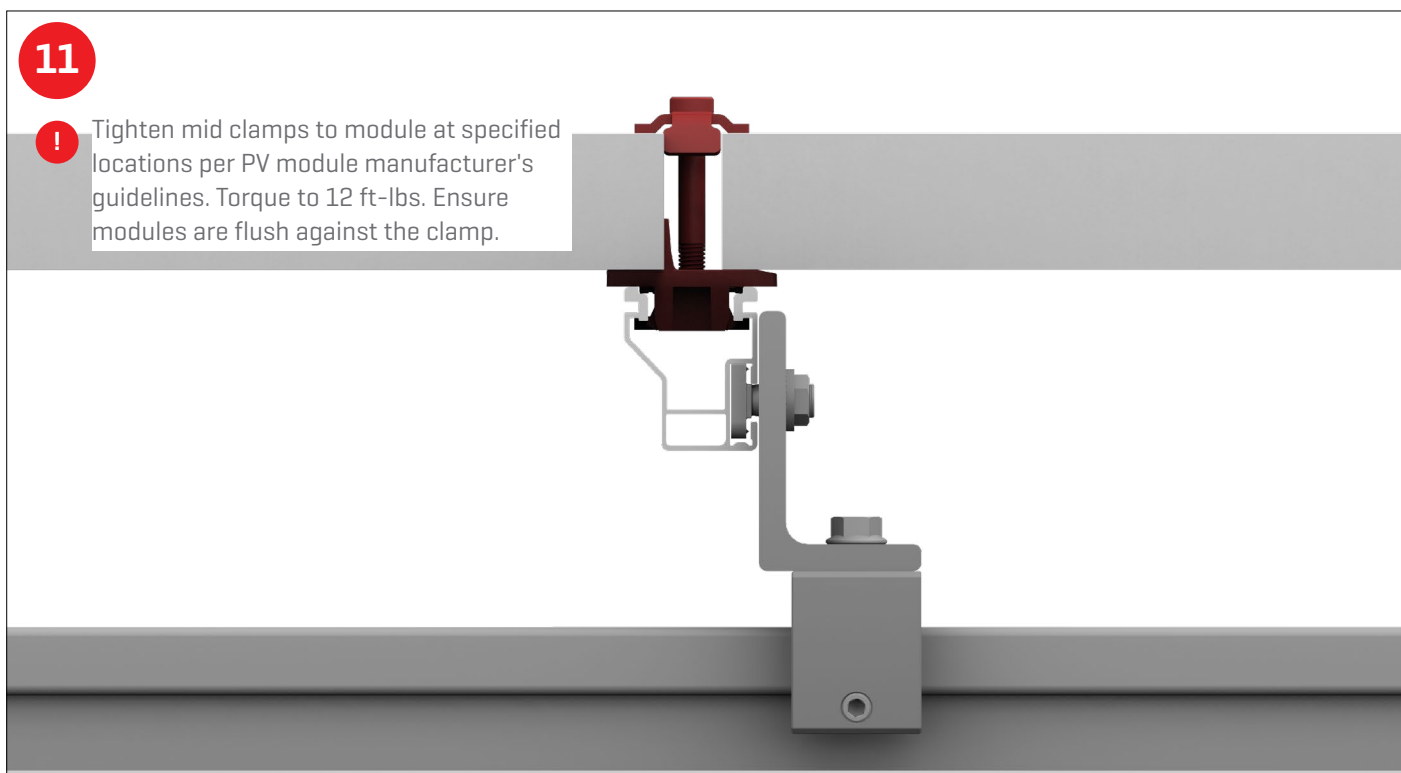
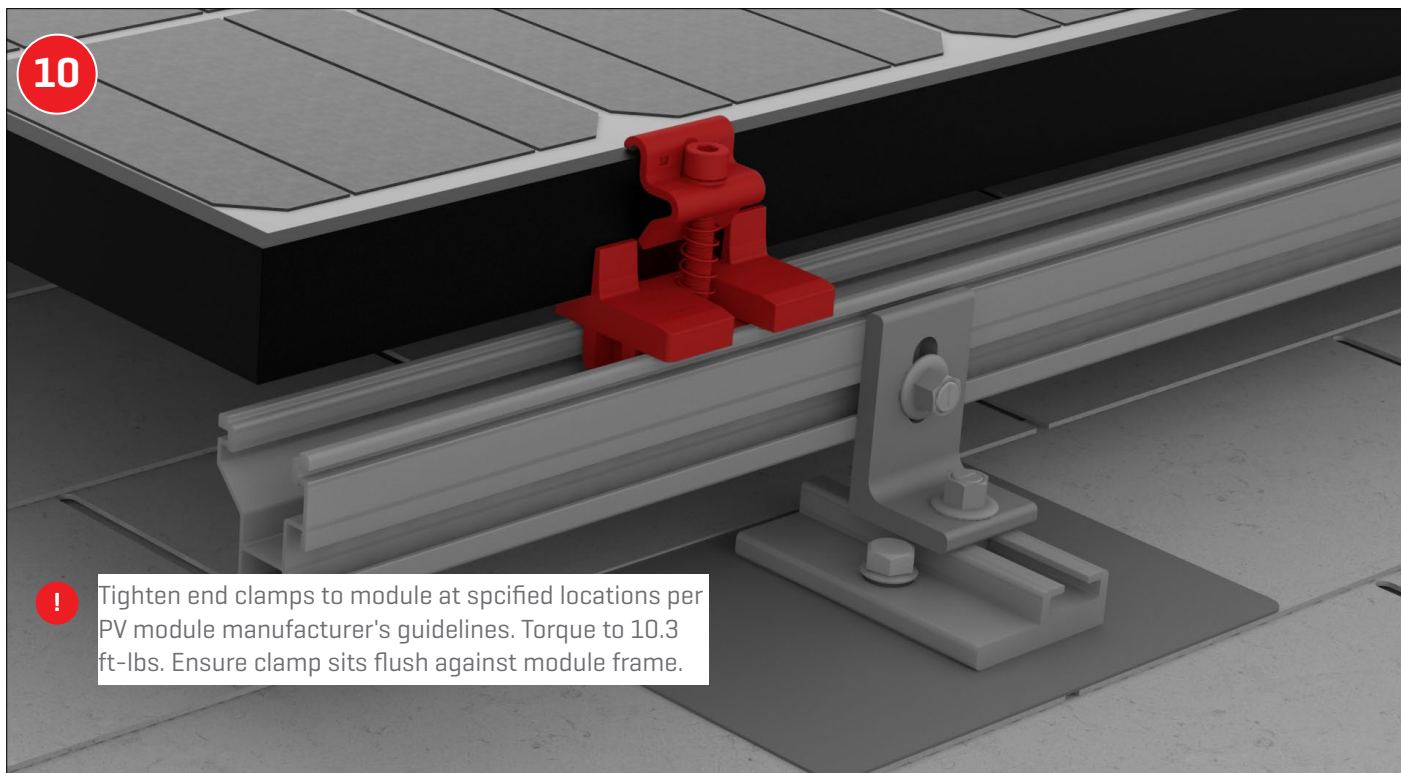

12

! Push pins of appropriate end cap into end of rail.

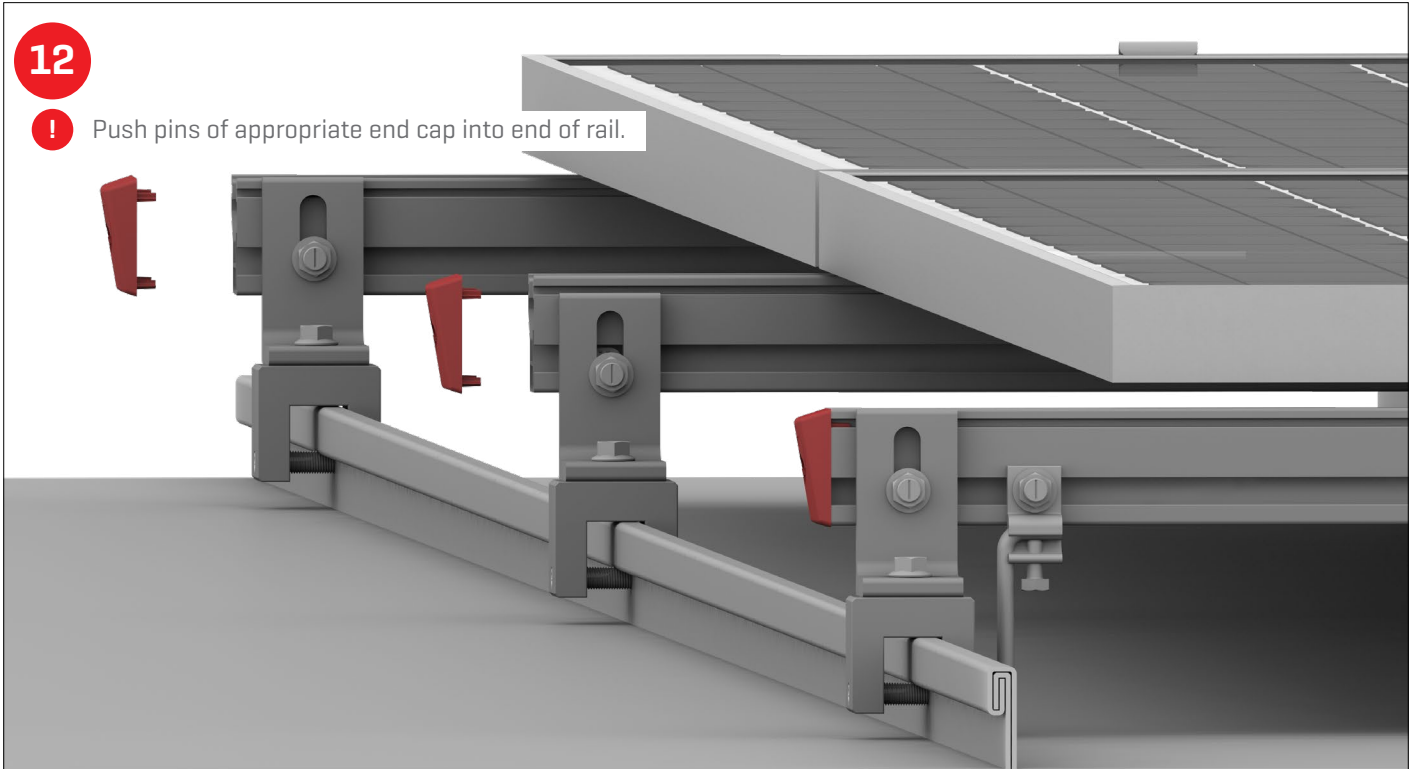

13a

! Insert the MK3 Slot Nut of the preassembled Everest Ground Lug into top channel of CrossRail. While slightly lifting the plastic tabs, rotate 90° clockwise to engage into rail channel. Ensure bonding teeth are perpendicular to the rail channel. Torque to 10 ft-lbs. Insert a #6 or #8 AWG solid copper wire and tighten terminal screw to 35-60 in-lbs. Please note if the Everest Ground Lug is used on a rail that is shared, it must be outside of the modules on the end of the rail. It can be used on one of the non-shared rails underneath the module or on the outside.

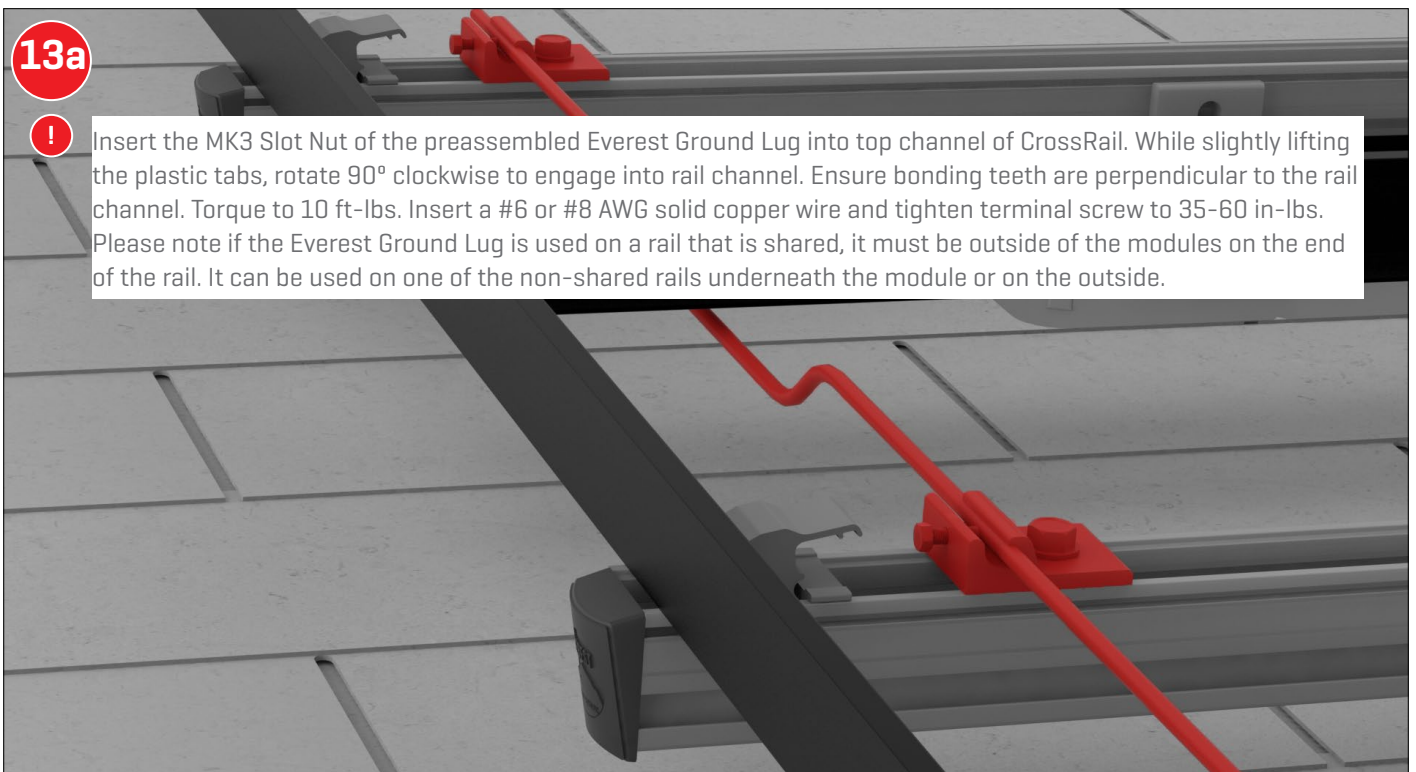

13b



To attach WEEB Lug 10.3, insert T-Bolt into side channel of CrossRail and rotate clockwise 90°. Tighten serrated hex nut to 15 ft-lbs [20.3 Nm]. Insert a #6 or #8 AWG solid copper wire and tighten terminal screw to 5 ft-lbs [6.7 Nm].

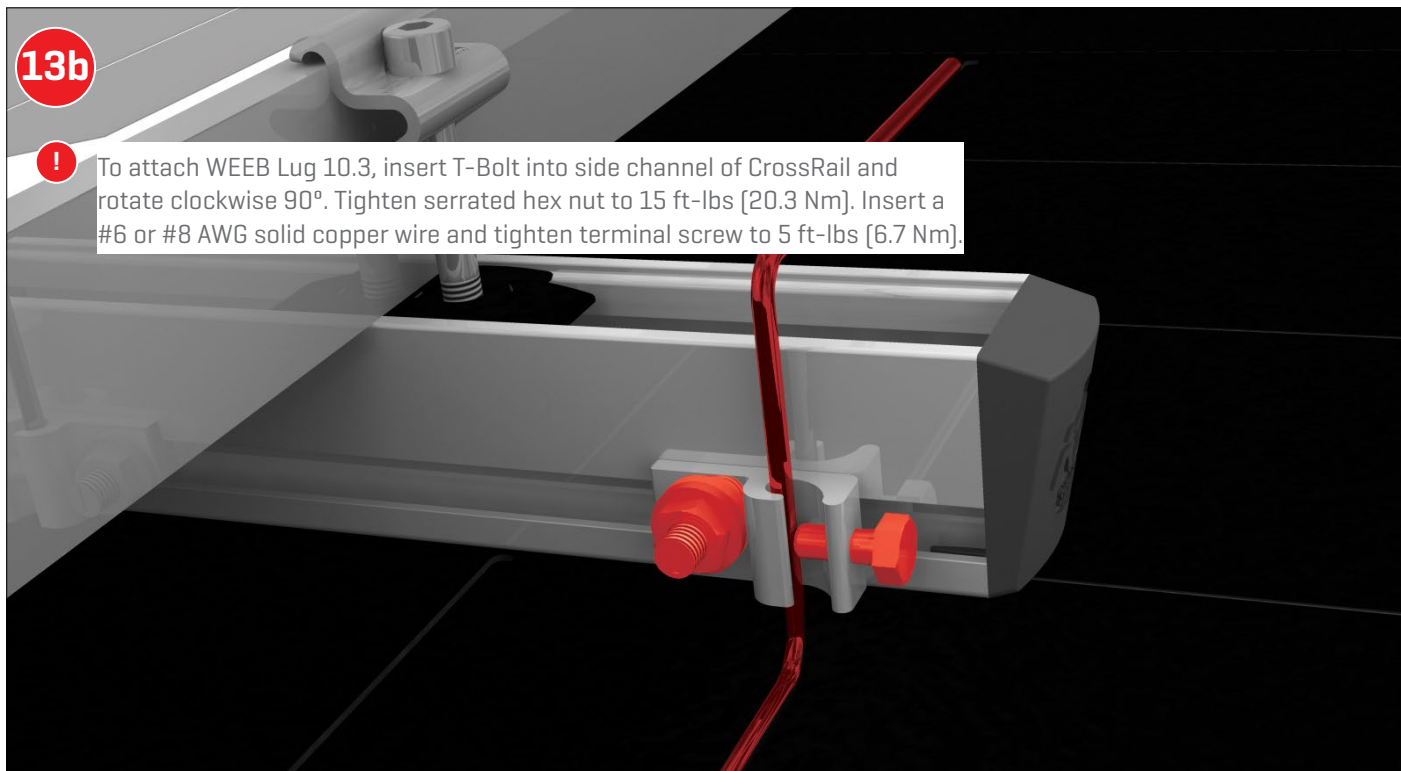

14



Front and rear rails can be offset to facilitate rail alignment and/or hide rail. Clamps may be used with or without the Add-On in this type of configuration. All intermediary rail between front and last rows must be aligned carefully using the steps outlined above.

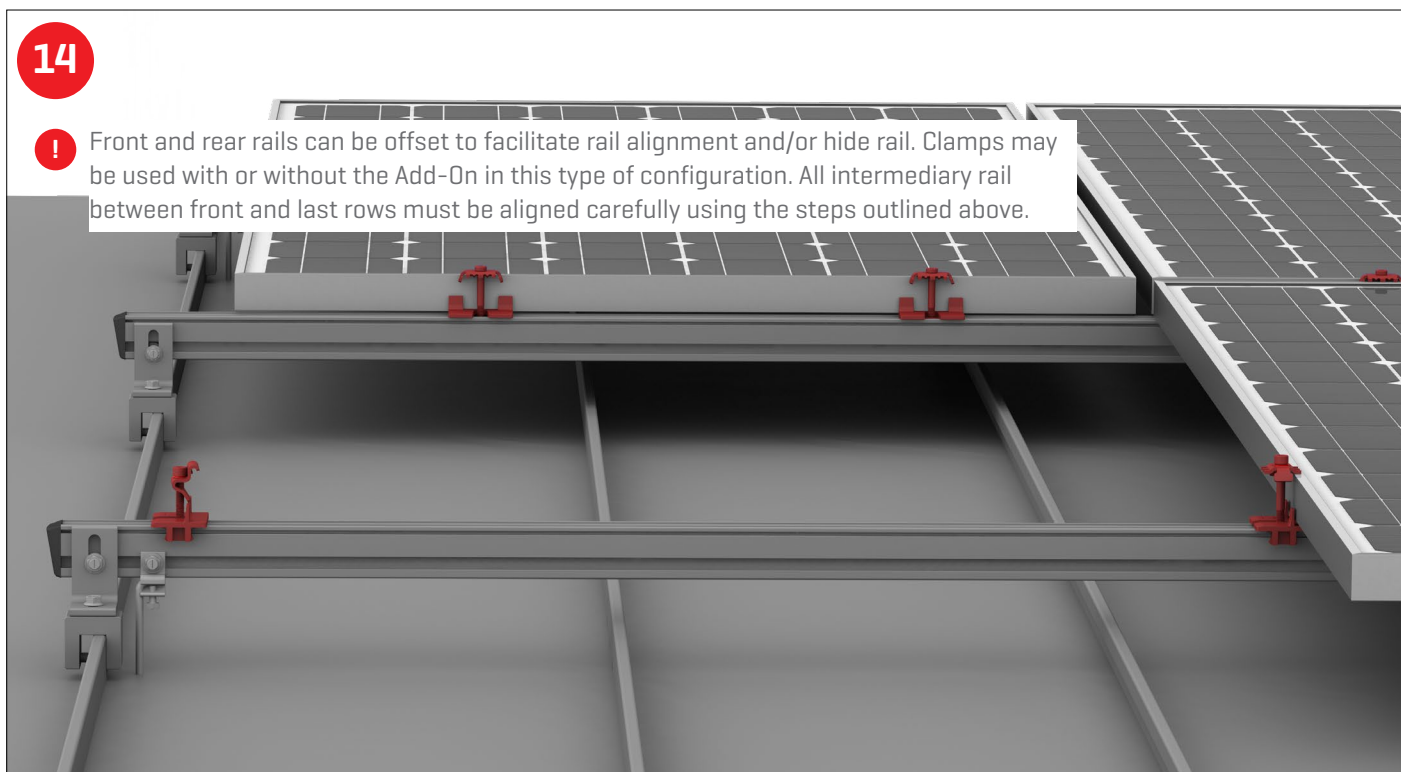

Notes

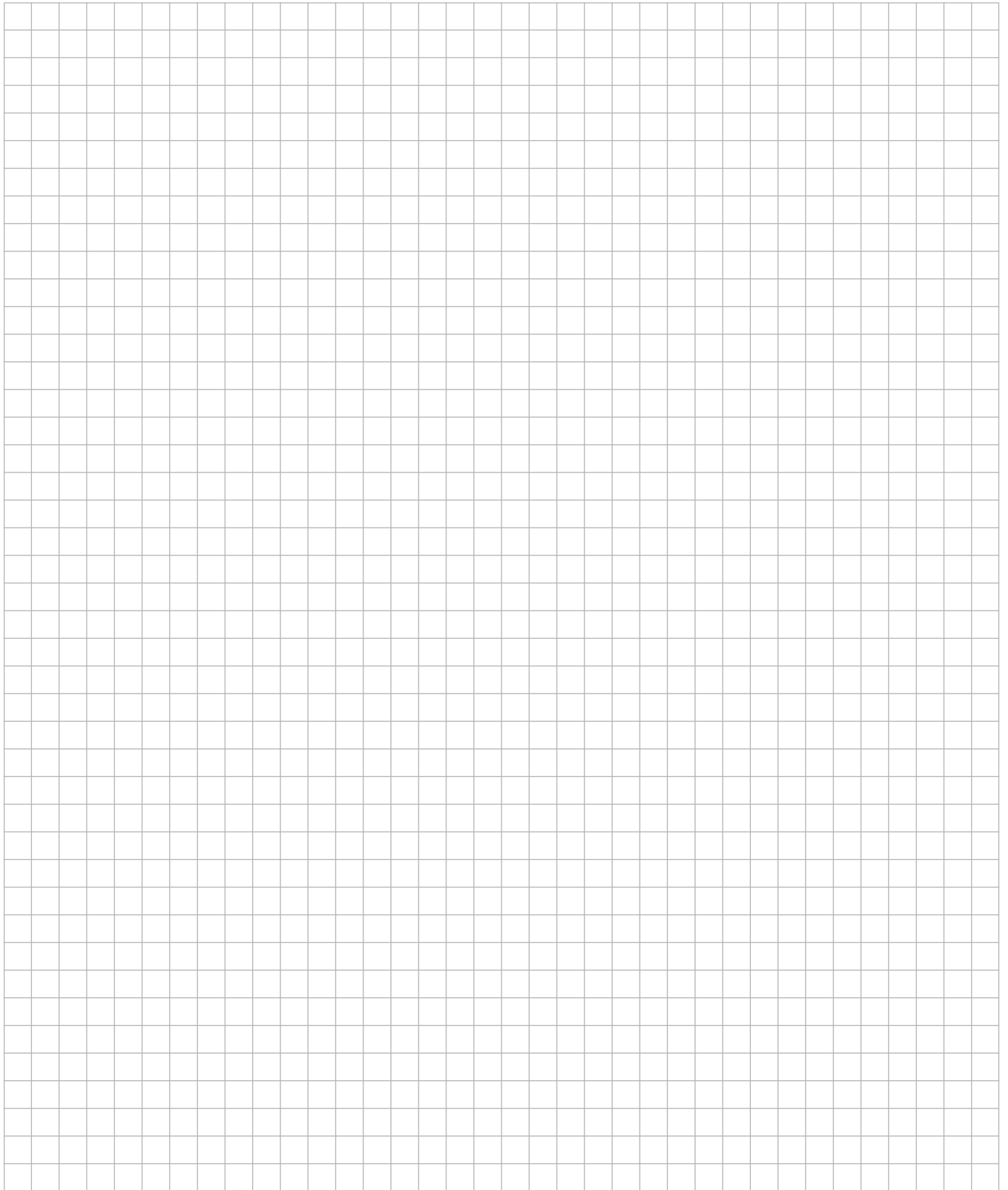

We support PV systems
Formerly Everest Solar Systems 



Thank you for choosing a K2 mounting system.

Systems from K2 Systems are quick and easy to install. We hope these instructions have helped. Please contact us with any questions or suggestions for improvement.

Our contact info:

- ▶ k2-systems.com/en-US/contact
- ▶ Telephone: +1.760.301.5300

K2 Systems, LLC
4665 North Avenue, Suite I
Oceanside, CA 92056
USA
+1.760.301.5300
info-us@k2-systems.com
www.k2-systems.com